





Type code: KF-S E15 AT65	
1.0	Tank drain DN 50, Ø 55 a, Connection pipe work and P-trap to be provided locally (DN 70)
2.01	Water connection of the machine: Soft warm water max. 65°C, DN 20, G 3/4 a max. 0,54 mmol/l CaCO ₃ (max. 3°dH) consumption approx. 80 l for tank filling
2.02	Water connection of the machine: Soft cold water 12 - 24°C, DN 20, G 3/4 a max. 0,54 mmol/l CaCO ₃ (max. 3°dH) consumption approx. 260 l/h for final rinse
3.0	Electrical connection of the machine: 3 PE 200V ~ 50Hz Connected load for peak: 93.4 A nominal current / - capacity: 93.4 A / 29.4 kW Max. Elect. cable cross-section: 120 mm ² free cable end from finished floor level/Wall: approx. 4 m ⚡ Voltage equalising cable The master switch must be provided on site
6.0	Heat load of warewash area The values apply for the following room conditions: Room temperature 22 °C, rel. humidity 55 % Distribution of the total heat load (machine 6.1 and washware 6.2) onto the suction surfaces during the washing operation. (Recommended suction surfaces in accordance with EN 16282): 6.01: approx. 67% 6.02: approx.33%
6.1	Heat load of the machine in normal washing operation: Latent: 3.4 kW, perceptible: 2.8 kW, total: 6.2 kW At a freshwater supply temperature of approx. 12°C
6.2	The heat load of the wash ware must be considered separately.
For the total space load, all other space loads must be considered. The space ventilation must be designed in accordance with EN 16282.	
	Recommended area for local supply lines (water, drain, electricity)
	Separation
Machine Equipment	
Exhaust air heat recovery	
Tank filling module	
Feeding table on site	
Discharge table on site	

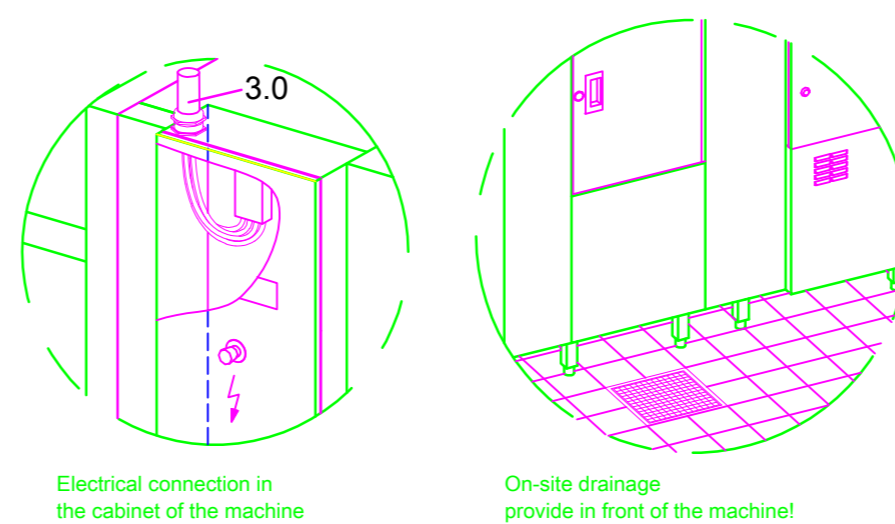
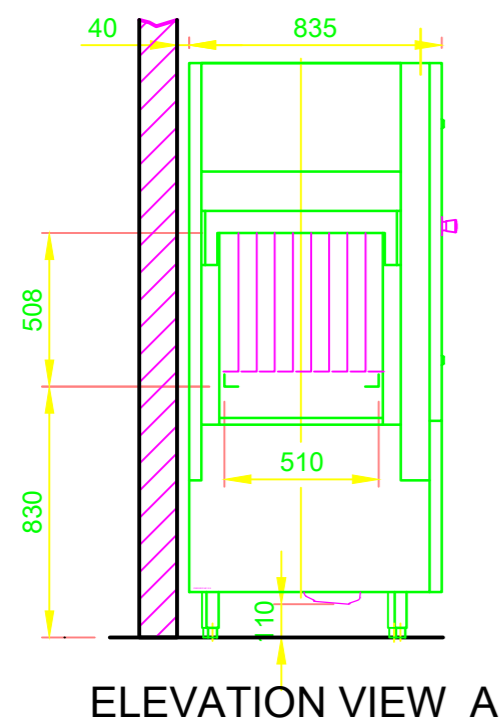
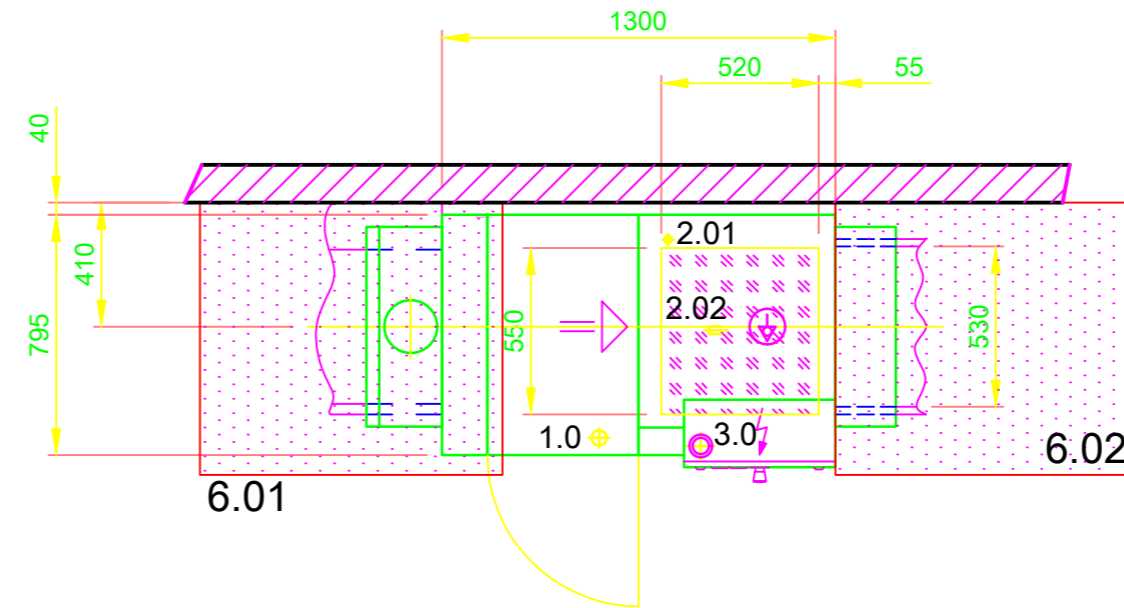
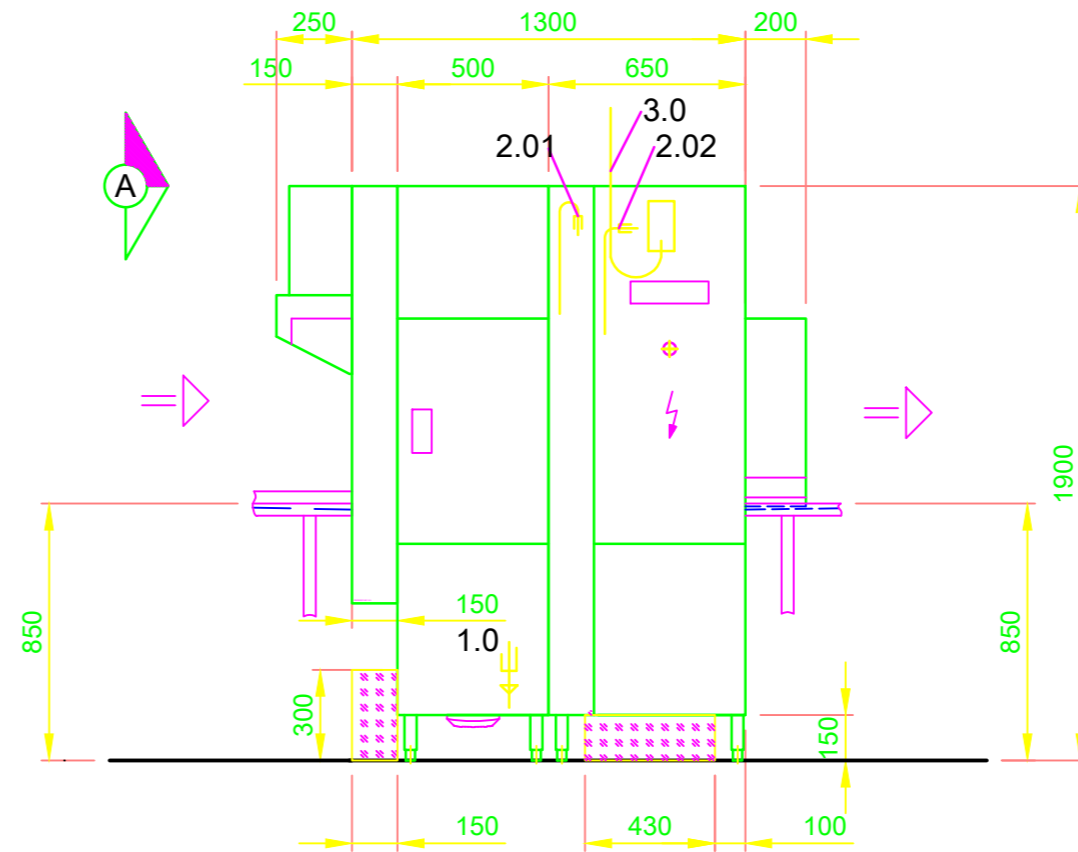

 MEIKO Clean Solutions Japan k.k. 2F 1-22-13 Asahiyaoka Nerima Tokyo Japan 176-0005 TEL +81 3 6914 4301 TELEFAX +81 3615 3820 E-MAIL: info@meiko-japan.com	Revision			
	Reference	UPSTER STANDARD DRAWING / JPN		Type
	Drawing-No.	S00088178		Order-No.
	Scale	1:25	drawn:	10.08.2020 m-iplan
This drawing may not be neither passed to third parties for their information or copied or used for competitive purposes without our consent. All rights reserved. We reserve the right to make changes resulting from technical progress. This drawing was computer generated and is not subject to the checking and any release process; it is also not subject to change management. Please note: This document is only valid in conjunction with the conditions defined in Supplementary Sheet "Important Information". These can be requested from the manufacturer or downloaded from the Partnernet.				UPSTER K-S 160 L-R ELECTRO
				checked: 10.08.2020 m-iplan